

Copyright © 2009 IEEE.

Reprinted from IEEE Signal Processing Magazine, 2009; 26 (1):32-41

This material is posted here with permission of the IEEE. Such permission of the IEEE does not in any way imply IEEE endorsement of any of the University of Adelaide's products or services. Internal or personal use of this material is permitted. However, permission to reprint/republish this material for advertising or promotional purposes or for creating new collective works for resale or redistribution must be obtained from the IEEE by writing to [pubs-permissions@ieee.org](mailto:pubs-permissions@ieee.org).

By choosing to view this document, you agree to all provisions of the copyright laws protecting it.

Robert Calderbank, Stephen D. Howard, and Bill Moran

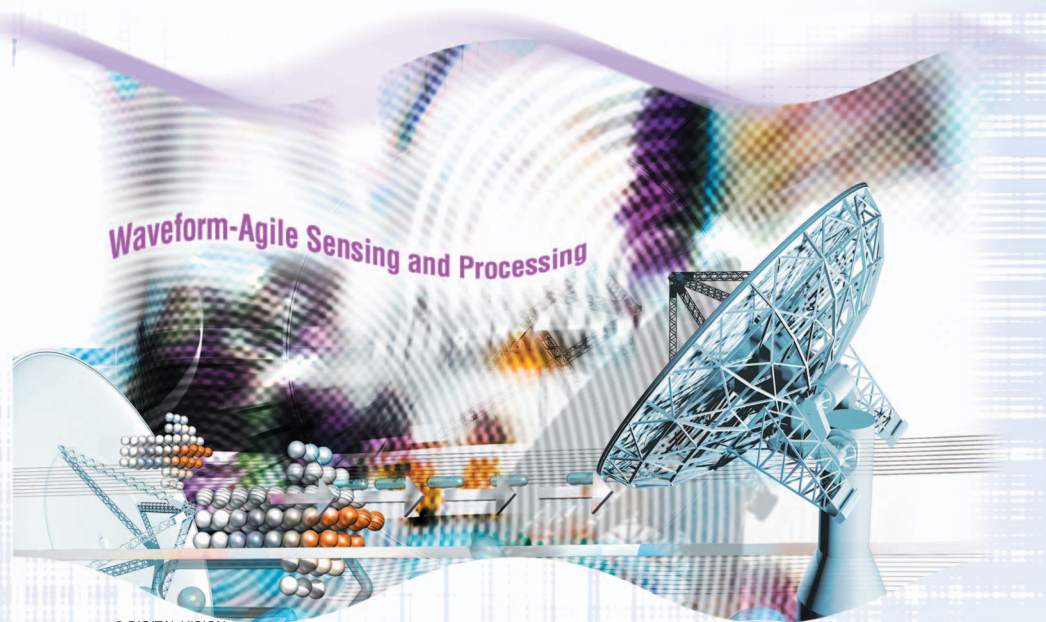

# Waveform Diversity in Radar Signal Processing

[ A focus on the use and control of degrees of freedom ]

**T**he advent of phased array radars and space-time adaptive processing has given radar designers the ability make radars adaptable on receive. The current state of radar technology allows the transmission of wavefields that vary across space, time, and frequency and that can be changed in rapid succession. The ability to exploit space-time adaptive processing is limited by the computational power available at the receiver, and increased flexibility on transmission only exacerbates this problem unless the waveforms are properly designed to simplify processing at the receiver.

Sixty years ago, efforts by Marcel Golay to improve the sensitivity of far infrared spectrometry led to the discovery of pairs of complementary sequences. Shortly thereafter, Welti proposed to use Golay sequences in radar, but they have found very limited application to date. This article shows that suitably

*Digital Object Identifier 10.1109/MSP.2008.930414*

transmitted and processed, radar waveforms based on Golay sequences provide new primitives for adaptive transmission that enable better detection and finer resolution, while managing computational complexity at the receiver.

### DEGREES OF FREEDOM AND RADAR SIGNAL PROCESSING

Advances in active sensing are enabled by the ability to control new degrees of freedom, and each new generation of radar platforms requires fundamental advances in radar signal processing [20], [30]. Later generations are distinguished by the increased dimensionality of the illumination pattern across the elements of the array (whether distributed or collocated), across available polarizations, and over time.

The simplest radars scan the antenna beam in azimuth and form an image of the environment by integrating one-dimensional views. Variation of pulse-repetition intervals (PRIs) resolves ambiguities, and processing of all ranges and Doppler shifts is simultaneous. Space-time adaptive processing (STAP) retains the single transmit beam direction but is electronically steerable, and digitization on receive enables adaptive beamforming to eliminate interference [30]. Advanced phased arrays introduce broad waveform adaptability (time, space, frequency, and polarization) leading to full distributed aperture functionality. These radars are able to transmit simultaneously in all directions, collect returns at multiple locations, and employ waveform adaptation to simplify signal processing.

### PHYSICAL DIVERSITY: SPACE AND POLARIZATION

A fundamental objective of radar engineers is the design of waveforms that effectively utilize radar resources (transmitters and receivers) that are distributed spatially in polarization, time, and frequency. To comprehend the physical picture, assume  $N$  fully polarimetric transmit and  $M$  fully polarimetric receive antennas. Also assume narrowband transmission, where the waveforms take the form of relatively slow modulations on a carrier frequency at each transmitter, so that the scattering cross section is constant in frequency across the bandwidth of the waveform. Given a single scatterer in the far field of each of the transmitters, the transmitted signals arrive at the scatterer as plane waves, with a direction of arrival  $\boldsymbol{\kappa}_n$  and complex polarization vector  $\boldsymbol{\epsilon}_n$ , which itself may be a slowly varying function of time. The radar cross section of the scatterer,  $\sigma(\boldsymbol{k}, \boldsymbol{e} | \boldsymbol{\kappa}, \boldsymbol{\epsilon})$ , is the relative amplitude at which an incoming electromagnetic (EM) plane wave from direction  $\boldsymbol{\kappa}$  and with polarization vector  $\boldsymbol{\epsilon}$  is scattered to an outgoing plane wave in the far field with propagation direction  $\boldsymbol{k}$  and polarization  $\boldsymbol{e}$ . We consider three scenarios, presenting very different design challenges:

- **Full diversity (FD):** The transmitters and/or the receivers are separated enough in space, relative to the range to the target, that the wave-vector dependence of  $\sigma(\boldsymbol{k}, \boldsymbol{e} | \boldsymbol{\kappa}, \boldsymbol{\epsilon})$  cannot be ignored. The radar cross section apparent to each of the transmitter-receiver pairs is different and fluctuations over time due to the scatterer's motion are statistically independent (see Figure 1).

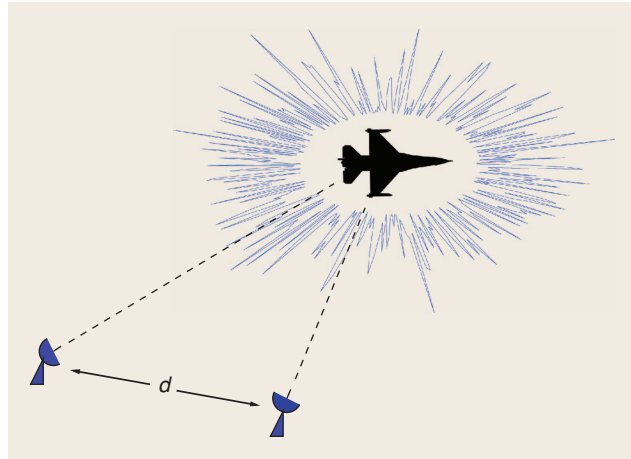

**[FIG1]** Widely separated antennas, relative to the range to the target, see different aspects of the target radar cross section.

- **Distributed Aperture—Coherent Target (CT):** The transmitters and/or receivers are sufficiently spatially separated to make true time-of-arrival processing necessary, but the scatterer is sufficiently distant that  $\sigma(\boldsymbol{k}, \boldsymbol{e} | \boldsymbol{\kappa}, \boldsymbol{\epsilon})$  is effectively constant across the transmit/receive arrays (see [17]).

- **Multiple-Input, Multiple-Output (MIMO) Phased Array (PA):** The scatterer is in the far field of the combined set of transmitters. The combined set of receivers is in the far field of the scatterer. The narrowband approximation holds across the receiver array; that is, at a given instant in time, the amplitude across the receive array due to scattering from the scatterer is constant.

All three of the situations fall under the umbrella of MIMO radar (although spatial separation without transmit waveform diversity is traditionally referred to a multistatic radar [28]), but each presents a very different waveform design/adaptation challenge. For example, the effect of waveforms on performance for phased arrays can be understood in terms of ambiguity functions and array manifolds. Most of the literature on MIMO radar falls into this category although this is often not made clear [9], [28].

A target can only be coherent if it is sufficiently distant relative to the size of transmit and receive arrays. For although  $\sigma(\boldsymbol{k}, \boldsymbol{e} | \boldsymbol{\kappa}, \boldsymbol{\epsilon})$  may be independent of  $\boldsymbol{k}$  for targets with spherical symmetry,  $\sigma(\boldsymbol{k}, \boldsymbol{e} | \boldsymbol{\kappa}, \boldsymbol{\epsilon})$  is certainly not a constant function of  $\boldsymbol{\kappa} - \boldsymbol{k}$ . Thus, we can characterize the “Distributed Aperture—CT” case by the transmit and receive arrays being compact enough, relative to target range, that  $\sigma(\boldsymbol{k}, \boldsymbol{e} | \boldsymbol{\kappa}, \boldsymbol{\epsilon})$  can be considered constant, while the transmit and receive arrays are distributed enough to make true time-delay signal processing necessary. This situation may also be analyzed in terms of an ambiguity function [16].

By contrast, the FD case cannot be analyzed in terms of a single ambiguity function and the development of a theoretical basis for waveform design and adaption is one of the major current challenges of FD radar [3], [31].

## WAVEFORM DIVERSITY

Modern radars are increasingly being equipped with arbitrary waveform generators that enable simultaneous transmission of different waveforms from different polarimetric antennas, even on a pulse-to-pulse basis. The available design space encompasses spatial location, polarization, time, and frequency. Thus, although we must respect time and bandwidth constraints, the number of possibilities is vast.

The complexity of the design problem motivates synthesis of waveforms from components having smaller time-bandwidth product and complementary properties. A waveform is assembled by sequencing the components in time and/or stacking them in frequency in such a way that they have negligible overlap. With this approach, the waveform design problem splits into two simpler pieces: the design of components that complement each other, and the design of time-frequency combinations of these components with desirable properties. Another advantage of modularity is that the time-frequency combinations can be varied in time to enable adaptive control of the radar's operation. Examples of this approach include pulse trains of orthogonal waveforms (separation in time) and what is often referred to as orthogonal frequency division multiplexing (OFDM) radar, where waveforms are separated in frequency.

## THE RADAR AMBIGUITY FUNCTION

For simplicity, we postpone consideration of the spatial and polarization degrees of freedom and focus on time/frequency aspects (collocated transmitter and receiver). The radar ambiguity function is the standard and convenient device to express blurriness of a scene as a result of illumination by a radar waveform and processing of the return by correlating with the transmitted waveform—matched filtering [2], [13], [29]. This optimizes the post-processing signal-to-noise ratio (SNR). The ambiguity function is, in a very real sense, the point-spread function for the range-velocity plane. Provided the transmitter and receiver are collocated, the ambiguity function for a waveform  $w$  is

$$A_w(x, f) = \int_{-\infty}^{\infty} w(t) \overline{w(t-x)} e^{2\pi i f t} dt, \quad (1)$$

and, for multiple scatterers at varying ranges and radial velocities, the processed received signal is obtained by taking a linear combination of shifts of the ambiguity at these ranges and velocities. The scalars involved in this linear combination are the radar cross sections of the scatterers. Moyal's identity [13] captures the fundamental limits on this blurriness. Mathematically, it is expressed as

$$\int_{-\infty}^{\infty} \int_{-\infty}^{\infty} |A_w(t, f)|^2 dt df = \left( \int_{-\infty}^{\infty} |w(t)|^2 dt \right)^2. \quad (2)$$

**A FUNDAMENTAL OBJECTIVE OF RADAR ENGINEERS IS THE DESIGN OF WAVEFORMS THAT EFFECTIVELY UTILIZE RADAR RESOURCES (TRANSMITTERS AND RECEIVERS) THAT ARE DISTRIBUTED SPATIALLY IN POLARIZATION, TIME, AND FREQUENCY.**

More intuitively, it puts a lower bound on the volume under the squared ambiguity surface as a function of the energy in the signal. It encapsulates, in a slightly different guise, the Heisenberg uncertainty principle. It should be clear that design of the ambiguity, or rather of the waveform, to achieve a given ambiguity with-

in the limitations imposed by Moyal's identity is an important issue for the radar engineer. The aim should be to move the inevitable volume under the (squared) ambiguity surface to regions where it matters least for the operational task of the radar.

It is important to bear in mind that the ambiguity is that of the waveform in its entirety. Choosing to transmit multiple pulses over time or across multiple frequency bands, and process in this way, or even in some other linear way, similar limitations will hold. In radar theory, it is customary to regard a waveform as a signal modulated onto a carrier and to separate the carrier modulation and demodulation processes from the ambiguity treatment. We want to emphasize that the carrier also plays a role in the ambiguity, and care has to be exercised in discussion of the situation where several carriers are involved [5]. We will return to this in later examples.

Why would we want to separate signals over time or over frequency? After all, if the correct approach is to calculate the ambiguity for the waveform in its entirety, then there would appear to be no reason to separate. Quite simply, separation simplifies design of waveforms. We hope this will become clearer when we discuss issues associated with Doppler processing, where the problem of ambiguity design is simplified by an approximate separation of the range and Doppler measurement problems. This is possible because, for short enough waveforms and for scatterers moving slowly enough, Doppler can be ignored as an intrapulse effect, and only has significance between pulses. This separation is at the heart of conventional processing techniques for pulse Doppler radars.

By choosing to separate waveforms in time, in frequency, or both, we modularize the design problem and reap the usual advantages attached to modularity in other areas of engineering. Unfortunately, there is a cost: ultimately we cannot escape Moyal. In the case of time or frequency separation of waveforms, this cost is related to the presence of the carrier. In particular, when the carrier is incorporated into the waveform in the calculation of the ambiguity, a phase factor emerges that is dependent on the range and/or Doppler of the scatterer.

To see this effect in the time-separated case, assume two waveforms  $w_1$  and  $w_2$  of short duration relative to their time separation  $T$ . The transmitted pulse is

$$w(t) = w_1(t) + w_2(t - T). \quad (3)$$

The ambiguity calculation for a scatterer at a distance  $R$ , moving at a radial velocity of  $v$ , is then, up to a phase factor and neglecting the range-aliased terms

$$A_w\left(\tau - \frac{2R}{c}, \phi - \frac{2f_c v}{c}\right) = A_{w_1}\left(\tau - \frac{2R}{c}, \phi - \frac{2f_c v}{c}\right) + e^{-2\pi i(\phi - 2f_c v/c)T} A_{w_2}\left(\tau - \frac{2R}{c}, \phi - \frac{2f_c v}{c}\right). \quad (4)$$

This expression makes it clear that the two ambiguities have a relative Doppler dependent phase factor that precludes addition of the ambiguities (see Figure 2).

If the waveforms are separated in frequency,

$$w(t) = w_1(t) + e^{2\pi i f_s t} w_2(t), \quad (5)$$

where  $f_s$  is the frequency separation, then the corresponding calculation, this time neglecting out-of-band Doppler terms gives

$$A_w\left(\tau - \frac{2R}{c}, \phi - \frac{2f_c v}{c}\right) = A_{w_1}\left(\tau - \frac{2R}{c}, \phi - \frac{2f_c v}{c}\right) + e^{-2\pi i f_s (\tau - 2R/c)} A_{w_2}\left(\tau - \frac{2R}{c}, \phi - \frac{2f_c v}{c}\right). \quad (6)$$

Again a relative phase factor, this time dependent on the range of the scatterer, prevents the result being a sum of ambiguities.

It is important to recognize from these calculations that the ambiguity of the full waveform is never the sum of the ambiguity functions of its frequency- or time-separated components. It is simply not possible to realize a summed or composite ambiguity function in a radar context. Indeed, conventional Doppler processing is a method of exploiting the above phase shift when the individual waveforms are separated in time, and of using it to estimate the radial velocity of a scatterer, and separate moving scatterers from stationary ones.

Matched filtering optimizes SNR as we have stated, but there are many radar applications where clutter is more of an issue than noise. It is appropriate to treat clutter according to a noise model if nothing is known about it. But once information is available, either through a model for the kind of clutter (for example, sea or land) or from measurements taken prior to the current one (or both), the information available can be used to constrain the clutter, and thereby buy improvement in radar performance by careful choice of the waveform.

## POLARIZATION

As in the spatial case, the radar cross section of an extended target, such as an aircraft or a ship, is highly sensitive to the angle of incidence and angle of view of the sensor (see [19, Sect. 2.7–2.8]). In general, the reflection properties that apply to each polarization component are also different and indeed, reflection can change the direction of polarization. Thus, polarimetric radars are able to obtain the scattering tensor of a target

$$\Sigma = \begin{pmatrix} \sigma_{VV} & \sigma_{VH} \\ \sigma_{HV} & \sigma_{HH} \end{pmatrix}, \quad (7)$$

where  $\sigma_{VH}$  denotes the target scattering coefficient into the vertical polarization channel due to a horizontally polarized incident field. Target detection is enhanced by concurrent rather than serial access to the cross-polarization components of the scattering tensor, which varies more rapidly in standard radar models used in target detection and tracking [18], [26] than in models used in remote sensing or synthetic aperture radar [12], [22].

In fact, what is measured is the combination of three matrices

$$H = \begin{pmatrix} h_{VV} & h_{VH} \\ h_{HV} & h_{HH} \end{pmatrix} = C_{R_x} \Sigma C_{T_x}, \quad (8)$$

where  $C_{R_x}$  and  $C_{T_x}$  correspond to the polarization coupling properties of the transmit and receive antennas, whereas  $\Sigma$  results from the target. In most radar systems the transmit and

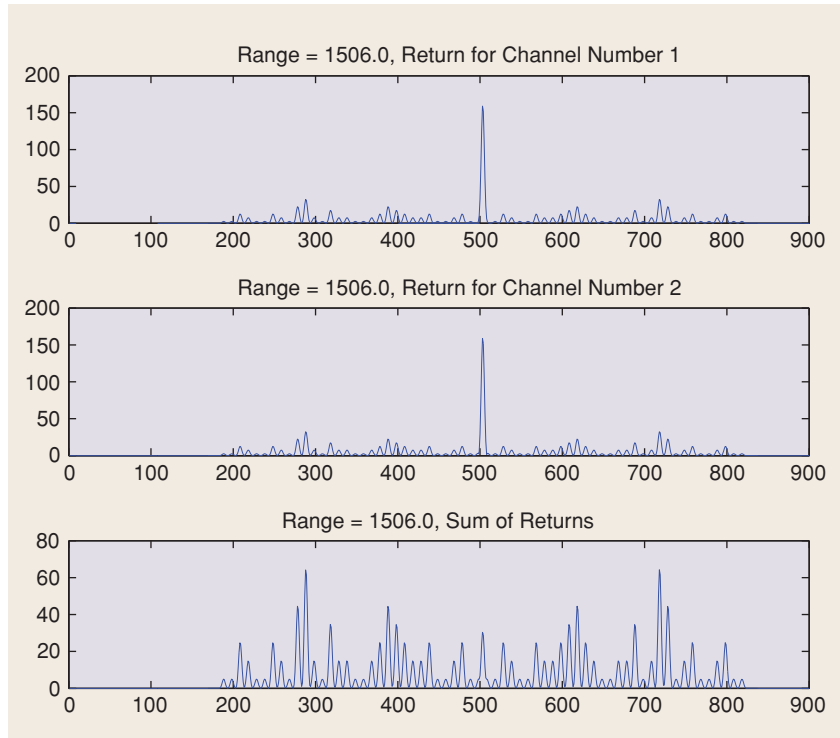

**[FIG2] Cancellation rather than complementarity. Frequency separated returns cancel due to range dependent phases. The precise effect on the sum of the returns depends on the range of the target modulo the chip length for the phase-coded pulse.**

receive antennas are common, and so the matrices  $C_{Tx}$  and  $C_{Rx}$  are conjugate. The cross-coupling terms in the antenna polarization matrices are clearly frequency- and antenna-geometry dependent but for the linearly polarized case this value is typically no better than about  $-20$  dB.

Following [10] we propose to use both polarization modes to transmit four phase-coded waveforms  $w_H^1, w_V^1, w_H^2, w_V^2$ . On each polarization mode, we transmit two phase-coded pulses separated by a time interval  $T$  or pulse-repetition interval (PRI). Thus, we transmit a first pair of waveforms  $w^1 = (w_V^1, w_H^1)$  followed by a second pair of waveforms  $w^2 = (w_V^2, w_H^2)$ . This passes through the channel defined by the target and antennas, to produce vectors  $r^j = Hw^j + z^j$  at the receiver, where the  $z^j$  are white Gaussian noise. We employ a paraunitary filter bank (see [21]) to coordinate transmission over the V and H channels; that is, we define

$$\begin{aligned} w_H^2 &= \widetilde{w_V^1} & (9) \\ w_V^2 &= -\widetilde{w_H^1} & (10) \end{aligned}$$

where  $\widetilde{\cdot}$  denotes complex conjugate time-reversal.

Conversion of all of the time-indexed sequences into the  $z$ -transform domain, and combination to form matrices:

$R(z) = (r^1(z)^T, r^2(z)^T)$ , and  $W(z) = (w^1(z)^T, w^2(z)^T)$  yields

$$R(z) = H(z)W(z) + Z(z). \quad (11)$$

Our aim is to extract  $H(z)$ , and this is facilitated by the choice of  $W(z)$  to be unitary (a paraunitary filter bank), which is equivalent to

$$w_V^1(z)\widetilde{w_V^1(z)} + w_H^1(z)\widetilde{w_H^1(z)} = 2Nz^{N-1}, \quad (12)$$

where  $N - 1$  is the degree of the polynomial  $w_1(z)$ . Polynomials with coefficients that are roots of unity and that satisfy (12) are complex Golay complementary polynomials [8], and their coefficients are Golay complementary sequences, which are characterized by the property that the sum of the two auto-correlation functions vanishes

at all (integer) delays other than zero (see Figure 3).

$$\text{corr}_{w_V}(k) + \text{corr}_{w_H}(k) = 2N\delta(k). \quad (13)$$

The classical Golay pairs, with coefficients  $\pm 1$ , were introduced by Golay to improve the sensitivity of far-infrared spectrometry [6]–[8], [15]. Golay pairs are widely studied in the radar and communications literature both as pairs and individually [27]. As individual waveforms they have favorable auto-correlation properties. These pairs have been constructed, in particular, with lengths  $2^n$  for all positive integers  $n$  [25].

### SPATIAL DIVERSITY

The concepts developed in the preceding section for polarization extend naturally to spatial diversity. Transmission of different waveforms from different radar elements (either distributed or collocated) over multiple PRIs has the effect of coordinatizing space. Leaving aside multipath issues, every point of space effectively receives a differently delayed combination of the waveforms, and so reflects back into the receivers this combination. By processing with several suitably chosen filter banks in the receivers, it is possible to separate the waveforms and to extract the position of the scatterers from the delays. In effect a multi-dimensional matched filter is performed.

At its simplest, such a scheme might work by time-separating very short pulses from each transmitter and collecting the delays at each receiver. This has the

**MODERN RADARS ARE INCREASINGLY BEING EQUIPPED WITH ARBITRARY WAVEFORM GENERATORS THAT ENABLE SIMULTANEOUS TRANSMISSION OF DIFFERENT WAVEFORMS FROM DIFFERENT POLARIMETRIC ANTENNAS, EVEN ON A PULSE-TO-PULSE BASIS.**

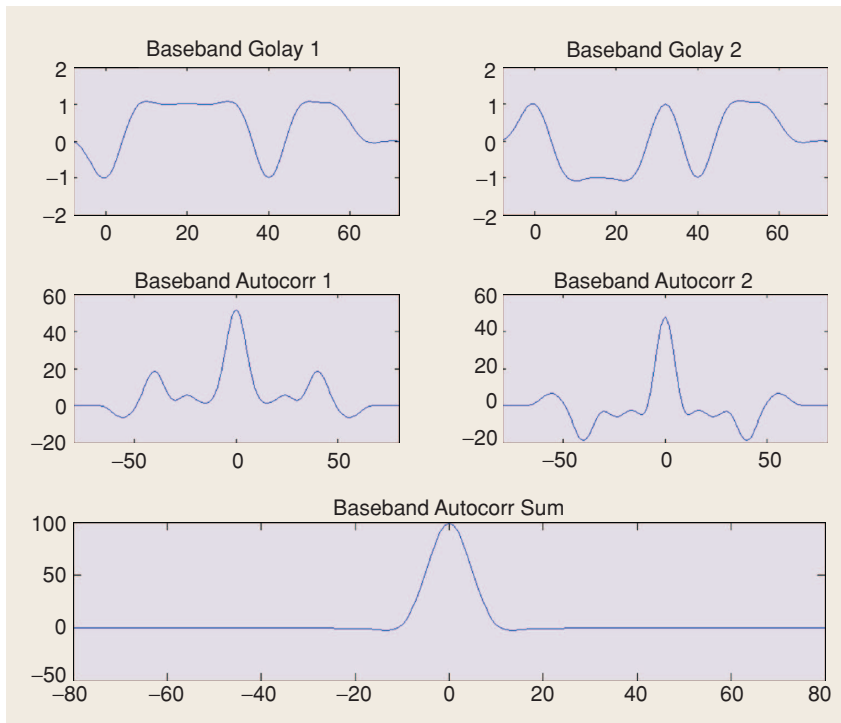

**[FIG3]** The Golay Property after low-pass filtering.

obvious disadvantage of low power and long-time duration. Conventional phased arrays effectively do an approximation to space-coordination by phase shifting transmit sequences and measuring (or rather combining) phases of returns in each receive element. Multiple PRIs are used to steer beams in different directions and thereby coordinatize the entire environment of illumination. Arrays that steer by time-delay rather than phase also coordinatize space over multiple PRIs in a similar way.

The particular unitary filter bank developed for polarization diversity is a special case of a more general construction of unitary matrices in which the individual elements are waveforms. Such matrices have been constructed by, for example, Tseng [24] to analyze acoustic surface wave phenomena. The methods of construction of these matrices of waveforms, as given in [23], are very flexible. Such a scheme can be used in either a collocated array or a distributed array of transmit-receive modules. Rows of the matrix are transmitted from different emitters over multiple PRIs, and the returns are match-filtered at every receiver. Collocation of transmitters and receivers is not necessary in this application. The array can be distributed, though processing relies on some measure of coherence. The processing over all transmissions is unitary and so is lossless.

One significant feature of this scheme is that multipath can be tagged. Since the illumination of a given point in space is uniquely determined by its position, returns from that point have a unique signature, and even if they arrive at the receiver after multiple reflections, their origin is still discernible from the nature of the return rather than just its time of arrival.

### TIME SEPARATION AND DOPPLER RESILIENCE

Why then have Golay complementary sequences not found application in radar systems? The answer, to quote Levanon [11, pp. 264], is: "Although the autocorrelation sidelobe level is zero, the ambiguity function exhibits relatively high sidelobes for nonzero Doppler." Ducoff and Tietjen [4] states "In a practical application, the two sequences must be separated in time, frequency, or polarization, which results in decorrelation of radar returns so that complete sidelobe cancellation may not occur. Hence they have not been widely used in pulse compression radars."

The effects of Doppler on a time-separated Golay pair are evident in the ambiguity picture in Figure 4 and, as a result, a pulse train formed by alternating the the components of a Golay pair will not be able to reliably detect even slowly moving targets.

However, all is not lost, and the freedom to sequence different Golay pairs makes possible the design of pulse trains for which the composite ambiguity function maintains ideal shape at small Doppler shifts. The key mathematical idea is to determine a sequence of Golay waveforms that annihilates the low-order terms of the Taylor expansion (around zero Doppler) of the composite ambiguity function [14].

More precisely, when a binary sequence  $p = (p_n)$  of length  $2^M$  is used to coordinate transmission of a Golay waveform pair  $x_0$  and  $x_1$  separated by a time  $T$  then, neglecting range-aliased terms, the ambiguity function  $A(l, \theta)$  is given by

$$A(l, \theta) = \frac{1}{2}(X_0(l) + X_1(l)) \sum_{n=0}^{2^M-1} \exp(i\theta n) + \frac{1}{2}(X_1(l) - X_0(l)) \sum_{n=0}^{2^M-1} p_n \exp(i\theta n), \quad (14)$$

where  $X_0(l)$  and  $X_1(l)$  are the auto-correlations of  $x_0$  and  $x_1$ .

The magnitude of the range sidelobes is proportional to the magnitude of the spectrum

$$D_p(\theta) = \sum_{n=0}^{2^M-1} p_n \exp(i\theta n). \quad (15)$$

Doppler resilience is achieved by choosing a sequence  $p$  with a spectral null at zero frequency and this is where the Prouhet-Thue-Morse (PTM) sequence [1] enters. The  $n$ th term is the sum of the binary digits of  $n$  modulo 2, and the sequence of length  $2^{M+1}$  is obtained from the sequence of length  $2^M$  by concatenation with its complement; thus the PTM sequences of lengths 2, 4, and 8 are 01, 0110, and 01101001. These sequences  $(p_n)_{n=1}^{2^M}$  have the remarkable property that

$$\sum_{n=1}^{2^M} (-1)^{p_n} n^k = 0, \quad \text{for } k = 0, 1, \dots, M-1, \quad (16)$$

and this provides the mechanism to kill the low-order terms in the Taylor series of  $D_p(\theta)$ . Ambiguity plots showing the difference between an alternating schedule and one adopting this method are shown in Figure 5.

### OFDM WAVEFORMS

Time separation of diverse waveforms has a number of disadvantages. First, we must place a lower limit on the time separation (PRI) in order to keep range aliasing manageable.

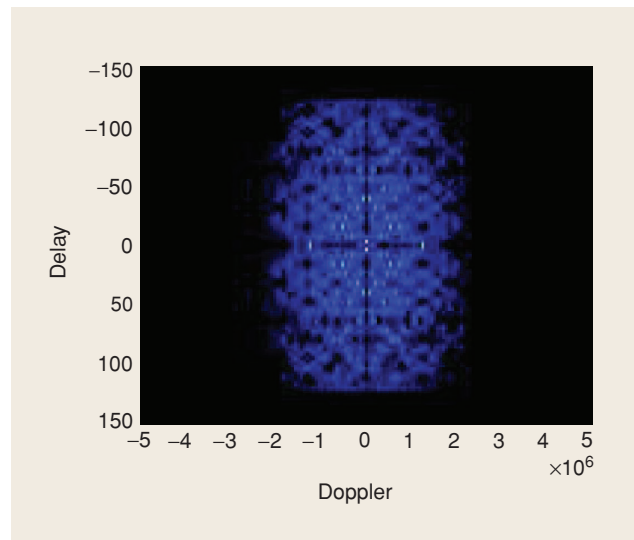

**[FIG4] Ambiguity of a time-separated Golay pair showing Doppler induced range sidelobes.**

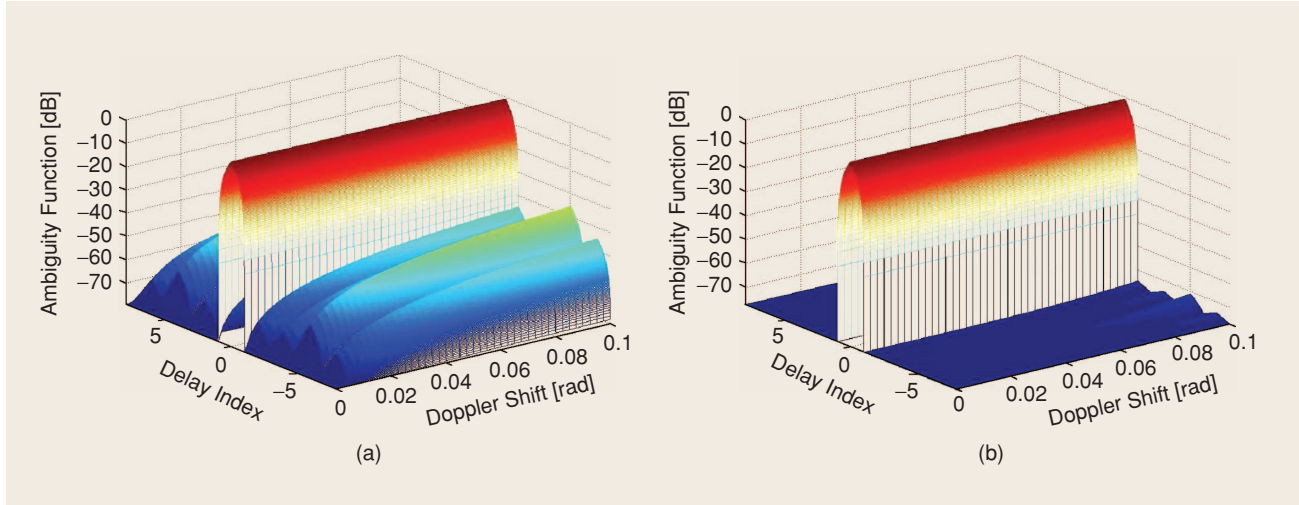

**[FIG5]** (a) The plot of the ambiguity function  $A(l, \theta)$  (corresponding to the Doppler resilient transmission scheme) versus delay index  $l$  and Doppler shift  $\theta$ , (b) the plot of the ambiguity function  $A(l, \theta)$  (corresponding to the conventional transmission scheme) versus delay index  $l$  and Doppler shift  $\theta$ . For a radar with carrier frequency 2.5 GHz and PRI = 100  $\mu$ s, the Doppler shift range of 0 to 0.05 rad (0.075 rad) corresponds to a maximum target speed of approximately 35 km/h (50 km/h). To cover a larger speed range we can use this design with a bank of Doppler filters to provide Doppler resilience within an interval around the Doppler frequency associated with each filter.

Further, although PTM pulse trains can give increased Doppler resilience many radar applications demand greater resilience than is achievable in this manner. The main limitation to gaining resilience by the PTM method is that increased Doppler resilience is gained at the expense of pulse trains of greater duration. This must be balanced by the requirement that the target maintains a relatively constant range and velocity over the interval of observation.

Frequency separation of the waveforms (OFDM radar) that exploits bandwidth rather than time offers a way forward [17]. However, we have seen that a pair of component waveforms with complementary autocorrelation or ambiguity functions do not retain this complementarity when multiplexed in frequency, due to the occurrence of a phase difference between frequency channels that depends on the unknown range to the target and the frequency difference between the channels. The individual filter outputs for each channel can not be combined coherently. This problem is common to all implementations of OFDM radar in which a

set of orthogonal or complementary waveform are transmitted on separate frequency channels and then combined after linear signal processing.

However, nonlinear signal processing can be used to transform this problem into one that is far more tractable. The idea for a pair of frequency separated component waveforms is to offset the components equally above and below the carrier (see Figure 6).

$$w(t) = e^{3\pi i B t} w_2(t) + e^{\pi i B t} w_1(t) + e^{-\pi i B t/2} w_1(t) + e^{-3\pi i B t/2} w_2(t). \quad (17)$$

When one component is equally offset above and below the carrier, the range dependent phase on the two channels are complex conjugate and so multiplying the two returns together gives a quantity that is independent of this phase. The result of this nonlinear processing is to produce the sum of the squares of the ambiguity functions

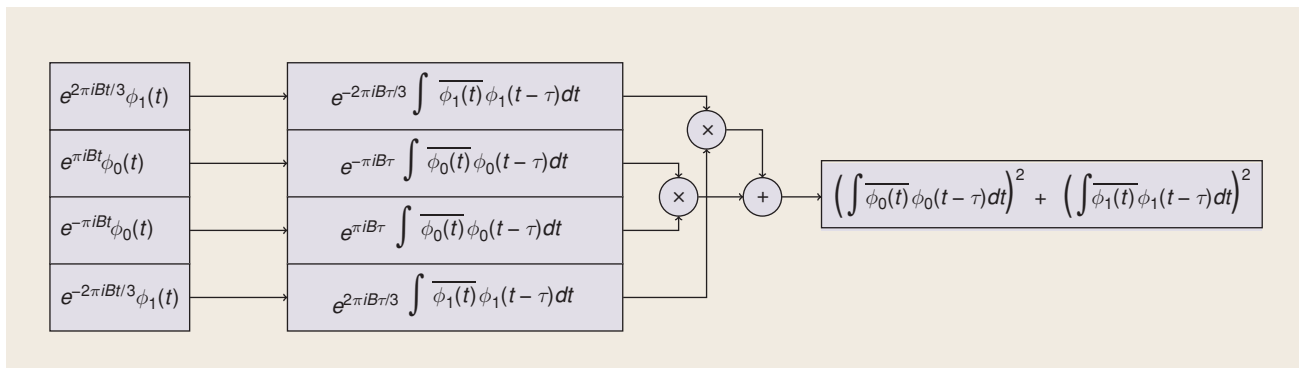

**[FIG6]** Frequency separation scheme.



$$\mathcal{A}_{w_0}(\tau, \phi)^2 + \mathcal{A}_{w_1}(\tau, \phi)^2. \quad (18)$$

$$\text{corr}_{w_1}^2(k) + \text{corr}_{w_2}^2(k) = 2N^2\delta(k). \quad (19)$$

The problem then becomes one of finding component waveforms for which the squares of their ambiguity or autocorrelation functions are complementary.

In order to recover the Golay complementary behavior in this scheme, we need to find quaternary-sequences with the property that

We refer to sequences and the corresponding waveforms having this property as square-Golay complementary. It turns out that there are many sequences that have this property when  $N$  is a power of two. Examples of length 16 are shown in (20) below.

$$\begin{matrix} 1 & 1 & 1 & -1 & 1 & 1 & -1 & 1 & 1 & 1 & 1 & -1 & -1 & -1 & 1 & -1 \\ 1 & 1 & 1 & -1 & 1 & 1 & -1 & 1 & i & i & i & -i & -i & -i & i & -i \\ 1 & i & -1 & i & 1 & i & 1 & -i & 1 & i & -1 & i & -1 & -i & -1 & i \\ 1 & i & -1 & i & 1 & i & 1 & -i & i & -1 & -i & -1 & -i & 1 & -i & -1 \end{matrix} \quad (20)$$

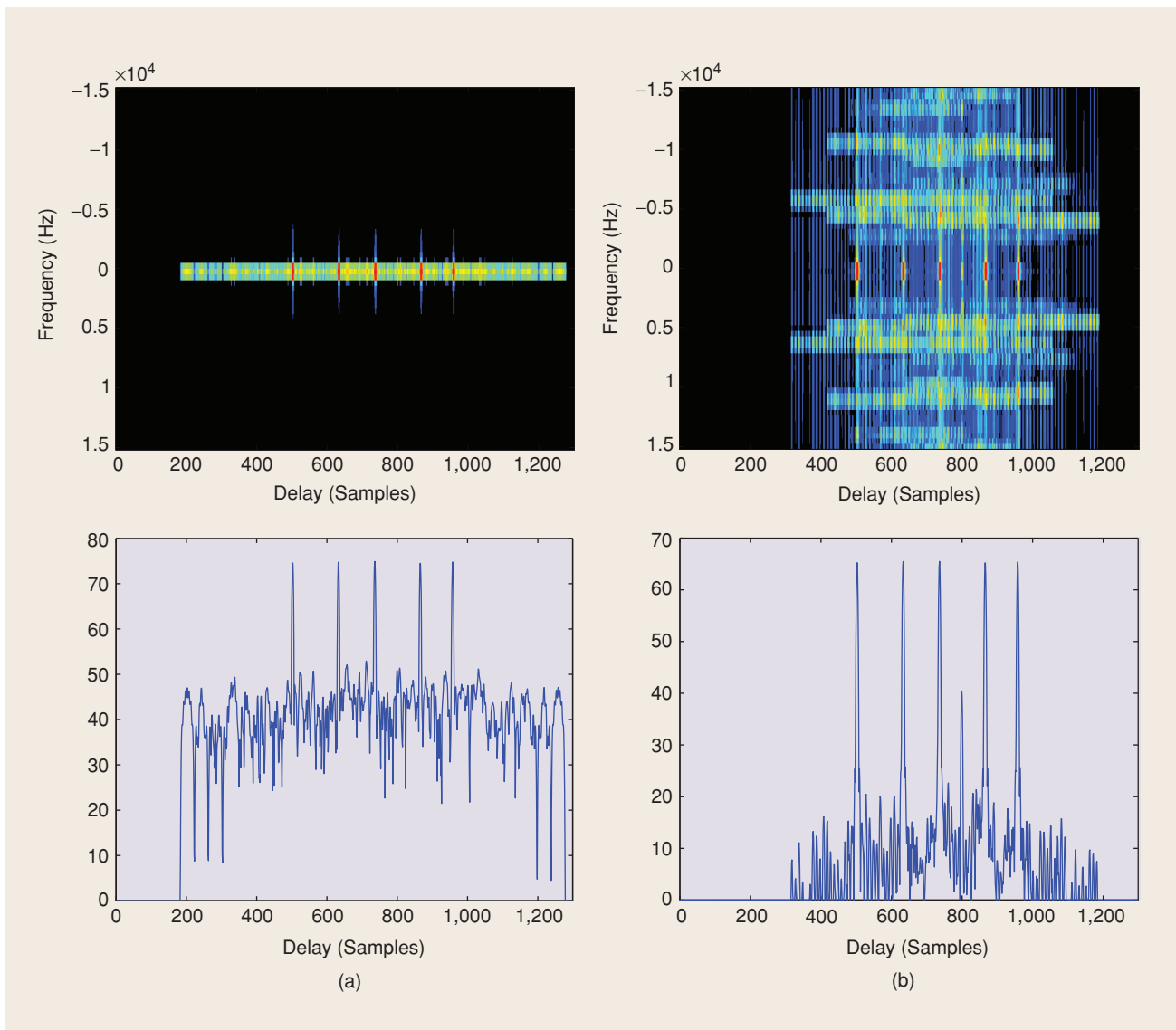

**[FIG7]** Results of a simulation of a weak target surrounded by several strong clutter returns. The weak return was at 2.37 km (790 samples). Five separate clutter returns were present within overlapping range of the weak return. Each clutter return was 25 dB more powerful than the weak return. (a) The result of Doppler processing a pulse train of 64, length-64, Frank-coded waveforms (chip length: 100 ns, carrier: 10 GHz, PRI: 33  $\mu$ s) and the zero-Doppler slice. (b) The result of nonlinear Doppler processing a pulse train of 64 Doppler resilient OFDM Golay-square waveforms with an initial separation of 10 MHz is increased by 75.8 kHz per pulse along the pulse train.

The second and third sequences are square-Golay partners for the first and fourth sequences. The second sequence is obtained from the first by multiplying the last half of the sequence by  $i$ , while the third sequence is obtained from the first by multiplying the  $k$ th element by  $i^k$ . The fourth sequence is obtained from the first by applying both of these transformations. This technique for generating Golay-square sequences from Golay sequences works for a large class of Golay sequences. In fact, we can generate Golay-square sequences from almost all length  $2^m$  Golay sequences by transformations related to the above transformation.

At the expense of doubling the transmission bandwidth, we can construct four component waveforms, transmitted over eight channel frequency channels, which have the Golay-square property

$$\text{corr}_{w_1}^2(k) + \text{corr}_{w_2}^2(k) + \text{corr}_{w_3}^2(k) + \text{corr}_{w_4}^2(k) = 4N^2\delta(k) \quad (21)$$

over the range of Doppler shifts generally encountered in radar detection. The four sequences in (20) form such a quartet. The advantage of frequency separation in obtaining Doppler resilience is that we need only cope with Doppler phase changes at the waveform chip level. This is in contrast to Doppler resilience for time separation where one must cope with Doppler phase changes across inter-pulse intervals. Coherent pulse trains of Doppler resilient OFDM pulses can be used to implement Doppler processing within the nonlinear signal processing regime.

So we have waveforms and a nonlinear processing scheme, which for a single target, realizes the promise of frequency-separated Golay complementary waveforms. We have produced a thumbtack combined autocorrelation that is Doppler resilient. A possible drawback is that since the matched-filtered signal is squared during processing, two closely-spaced targets produce cross terms in addition to the returns from the two targets. Our scheme has replaced sidelobes by cross terms. Sidelobes can be mitigated by the use of amplitude-weighting in the filters, or by post-processing filter output. Another strategy is to modulate the signal pulse by a phase code with good autocorrelation properties. Binary codes and polyphase codes have been used for this purpose (see [4] and [11]). Manipulation of cross terms presents an entirely new design space. The behavior of cross terms is very different from that of sidelobes. Firstly, the size of the cross terms between two targets depends on the magnitude of both targets. Secondly, whereas waveform sidelobes are difficult to manipulate, the position of cross terms in range and Doppler can be controlled by simple changes in transmission. We illustrate this with an example shown in Figure 7, where a modest linear

**ADVANCES IN ACTIVE SENSING ARE ENABLED BY THE ABILITY TO CONTROL NEW DEGREES OF FREEDOM, AND EACH NEW GENERATION OF RADAR PLATFORMS REQUIRES FUNDAMENTAL ADVANCES IN RADAR SIGNAL PROCESSING.**

modulation of the frequency spacing of OFDM channels across a pulse train can be used to move cross terms to other part of the range Doppler plane, thus revealing a small target. In general, by varying the frequency-offset modulation from pulse train (coherent processing interval) to pulse train, we can make the cross

term behave like noise, allowing a multitarget tracker to pick out the real targets from clutter interference.

**CONCLUSIONS**

This article has focused on the use and control of degrees of freedom in the radar illumination pattern. Our basic unit of illumination is a matrix of phase coded waveforms indexed by array element and by the PRI, where the polarization of constituent waveforms may vary. Choosing this matrix to be a unitary filter bank simplifies radar signal processing considerably. It also makes it possible to isolate and calibrate methods of controlling individual degrees of freedom before examining them in combination. This focus on unitary filter banks leads to the complementary waveforms developed by Golay to improve the sensitivity of far infrared spectrometry and to those developed by Tseng and Liu to analyze acoustic surface wave phenomena. As early as 1961, Welti had suggested the use of these complementary waveforms in radar, but to date, this has been precluded by the problems of Doppler induced range sidelobes and range dependent phase shifts when the waveforms are separated in frequency.

These roadblocks served as the starting point for research described in this article. We have described how to design pulse trains for which the composite ambiguity function maintains ideal shape at small Doppler shifts. We have also described new nonlinear signal processing methods that enable use of complementary waveforms in OFDM radar and provide Doppler resilience at the chip level. Looking to the future, we see unitary filter banks as a new illumination paradigm that enables broad waveform adaptability across time, space, frequency, and polarization.

**ACKNOWLEDGMENTS**

The authors would like to acknowledge Doug Cochran, Ali Pezeshki, Stuart Schwartz, and the anonymous reviewers for helpful comments and suggestions. This work was supported in part by the National Science Foundation under Grant 0701226, the Department of the Navy, Office of Naval Research under Grant N00014-02-100398, and the Air Force Office of Scientific Research under MURI Grant AFOSR-FA9550-05-1-0443. This work is proudly supported by International Science Linkages established under the Australian government's innovation statement, "Backing Australia's ability."

## AUTHORS

**Robert Calderbank** (calderbk@math.princeton.edu) received the B.Sc. degree in 1975 from Warwick University, England, M.Sc. degree in 1976 from Oxford University, England, and Ph.D. degree in 1980 from the California Institute of Technology, all in mathematics. He is a professor of electrical engineering and mathematics at Princeton University where he directs the program in applied and computational mathematics. He has made significant contributions to a wide range of research areas, from algebraic coding theory and quantum computing to wireless communication, magnetic recording, and active sensing. He was elected to the U.S. National Academy of Engineering in 2005. He is a Fellow of the IEEE.

**Stephen D. Howard** (Stephen.Howard@dsto.defence.gov.au) graduated in 1982 from La Trobe University, Melbourne, Australia. He received his M.S. and Ph.D. degrees in mathematics from La Trobe University in 1984 and 1990, respectively. He joined the Australian Defence Science and Technology Organisation (DSTO) in 1991, where he has been involved in research in the area electronic surveillance and radar systems. He has led the DSTO research effort into the development of algorithms in all areas of electronic surveillance, including radar pulse-train deinterleaving, precision radar parameter estimation and tracking, estimation of radar intrapulse modulation, and advanced geolocation techniques. Since 2003, he has led the DSTO long-range research program in radar resource management and waveform design.

**Bill Moran** (b.moran@ee.unimelb.edu.au) is a professor of electrical engineering at the University of Melbourne, Australia, where he is the Technical Director of the Melbourne Systems Laboratory. Previously, he was a professor of mathematics at the University of Adelaide and Flinders University. He also serves as a Consultant to the Australian Department of Defence through the Defence Science and Technology Organisation. His research interests are in signal processing, particularly with radar applications, waveform design and radar theory, and sensor management. He also works in various areas of mathematics, including harmonic analysis and number theory and has published widely in these areas. He is a Member of the IEEE.

## REFERENCES

- [1] J.P. Allouche and J. Shallit, "The ubiquitous Prouhet-Thue-Morse sequence," *Sequences and Their Applications, Proc. SETA'98*, T.H.C. Ding and H. Niederreiter, Eds., New York: Springer-Verlag, 1999, pp. 1–16.
- [2] L. Auslander and R. Tolimieri, "Radar ambiguity functions and group theory," *SIAM J. Math. Anal.*, vol. 16, no. 3, pp. 577–601, 1985.
- [3] I. Bradari, G.T. Capraro, M.C. Wicks, and P. Zulch, "Signal processing and waveform selection strategies in multistatic radar systems," in *Proc. Waveform Diversity and Design Conf.*, Pisa, Italy, June 2007, pp. 307–311.

## LOOKING TO THE FUTURE, WE SEE UNITARY FILTER BANKS AS A NEW ILLUMINATION PARADIGM THAT ENABLES BROAD WAVEFORM ADAPTABILITY ACROSS TIME, SPACE, FREQUENCY, AND POLARIZATION.

- [4] M.R. Ducoff and B.W. Tietjen, "Pulse compression radar," in *Radar Handbook*, M. I. Skolnik, Ed. New York: McGraw-Hill, 2008.
- [5] J.-C. Guey and M.R. Bell, "Diversity waveform sets for delay-Doppler imaging," *IEEE Trans. Inform. Theory*, vol. 44, no. 4, pp. 1505–1522, 1998.
- [6] M.J.E. Golay, "Multi-slit spectrometry," *J. Optical Soc. Amer.*, vol. 39, pp. 437–444, June 1949.
- [7] M.J.E. Golay, "Static multislit spectrometry and its application to the panoramic display of infrared spectra," *J. Optical Soc. Amer.*, vol. 41, pp. 468–472, July 1951.
- [8] M.J.E. Golay, "Complementary series," *IRE Trans. Inform. Theory*, vol. 7, no. 12, pp. 82–87, 1961.
- [9] A.M. Haimovich, R.S. Blum, and L.J. Cimini Jr., "Mimo radar with widely separated antennas," *IEEE Signal Process. Mag.*, vol. 25, no. 1, pp. 116–129, 2008.
- [10] S.D. Howard, A.R. Calderbank, and W. Moran, "A simple signal processing architecture for instantaneous radar polarimetry," *IEEE Trans. Inform. Theory*, vol. 53, no. 4, pp. 1282–1289, 2007.
- [11] N. Levanon and E. Mozeson, *Radar Signals*. Hoboken: Wiley, 2004.
- [12] R.K. Moore, "Ground echo," in *Radar Handbook*, M.I. Skolnik, Ed. New York: McGraw-Hill, 2008.
- [13] W. Moran, "The mathematics of radar," in *Twentieth Century Harmonic Analysis—A Celebration*, (NATO Science Series, NATO), J.S. Byrnes, Ed. Norwell, MA: Kluwer, pp. 295–328, 2001.
- [14] A. Pezeshki, A.R. Calderbank, W. Moran, and S.D. Howard, "Doppler resilient waveforms with perfect autocorrelation," *IEEE Trans. Inform. Theory*, vol. 54, no. 9, pp. 4254–4266, Sept. 2008.
- [15] N.J.A. Sloane, T. Fine, P.G. Phillips, and M. Harwit, "Codes for multiplex spectrometry," *Appl. Optics*, vol. 8, pp. 2103–2106, 1969.
- [16] G. San Antonio, D.R. Fuhrmann, and F.C. Robey, "MIMO radar ambiguity functions," *IEEE J. Select. Topics Signal Process.*, vol. 1, no. 1, pp. 167–177, 2007.
- [17] S.J. Searle, S.D. Howard, and W. Moran, "On the formation of composite ambiguity functions with frequency separated golay coded pulses," *IEEE Trans. Aerosp. Electron. Syst.*, to be published.
- [18] M.I. Skolnik, Ed., *Radar Handbook*, 2nd ed. New York: McGraw-Hill, 1990, ISBN: 0-07-057913-X.
- [19] M.I. Skolnik, Ed., *Introduction to Radar Systems*, 3rd ed. New York: McGraw-Hill, 2001.
- [20] M.I. Skolnik, Ed., *An Introduction and Overview of Radar*, 3rd ed. New York: McGraw-Hill, 2008.
- [21] G. Strang and T. Nguyen, *Wavelets and Filter Banks*, 2nd ed. Cambridge, MA: Wellesley-Cambridge, 1997.
- [22] R. Sullivan, "Synthetic Aperture Radar," in *Radar Handbook*, M.I. Skolnik, Ed. New York: McGraw-Hill, 2008.
- [23] C.C. Tseng and C.L. Liu, "Complementary sets of sequences," *IEEE Trans. Inform. Theory*, vol. 18, no. 5, pp. 644–652, 1972.
- [24] C.C. Tseng, "Signal multiplexing in surface-wave delay lines using orthogonal pairs of Golay's complementary sequences," *IEEE Trans. Sonics Ultrasonics*, vol. 18, no. 2, pp. 103–107, 1971.
- [25] R.J. Turyn, "Ambiguity functions of complementary sequences," *IEEE Trans. Inform. Theory*, vol. 9, no. 1, pp. 46–47, 1963.
- [26] H.L. van Trees, *Detection, Estimation and Modulation Theory, Part III*. New York: Wiley, 1971.
- [27] G.R. Welfl, "Quaternary codes for pulsed radar," *IRE Trans. Inform. Theory*, vol. 6, pp. 400–408, June 1960.
- [28] N.J. Willis, "Bistatic radar," in *Radar Handbook*, M.I. Skolnik, Ed. New York: McGraw-Hill, 2008.
- [29] P.M. Woodward, *Probability and Information Theory with Applications to RADAR*. New York: Pergamon, 1953.
- [30] M.C. Wicks, M. Rangaswamy, R. Adve, and T.B. Hale, "Space-time adaptive processing," *IEEE Signal Process. Mag.*, vol. 24, no. 1, pp. 51–65, 2006.
- [31] Y. Zhang, G.J. Frazer, and M.G. Amin, "Concurrent operation of two over-the-horizon radars," *IEEE J. Select. Topics Signal Process.*, vol. 1, no. 1, pp. 114–123, 2007.

